

SYM	REVISION	BY	DATE	ECN
A	ENGINEERING RELEASE	DLM	05-07-91	20150
B	TITLE WAS INPUT SHAFT INSTALLATION	JMS	03-27-96	27970

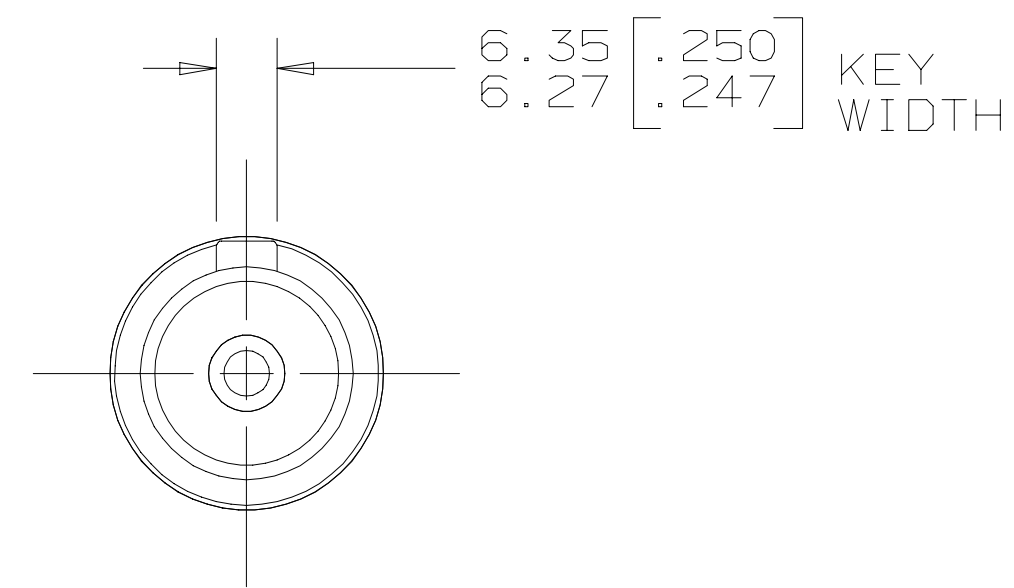
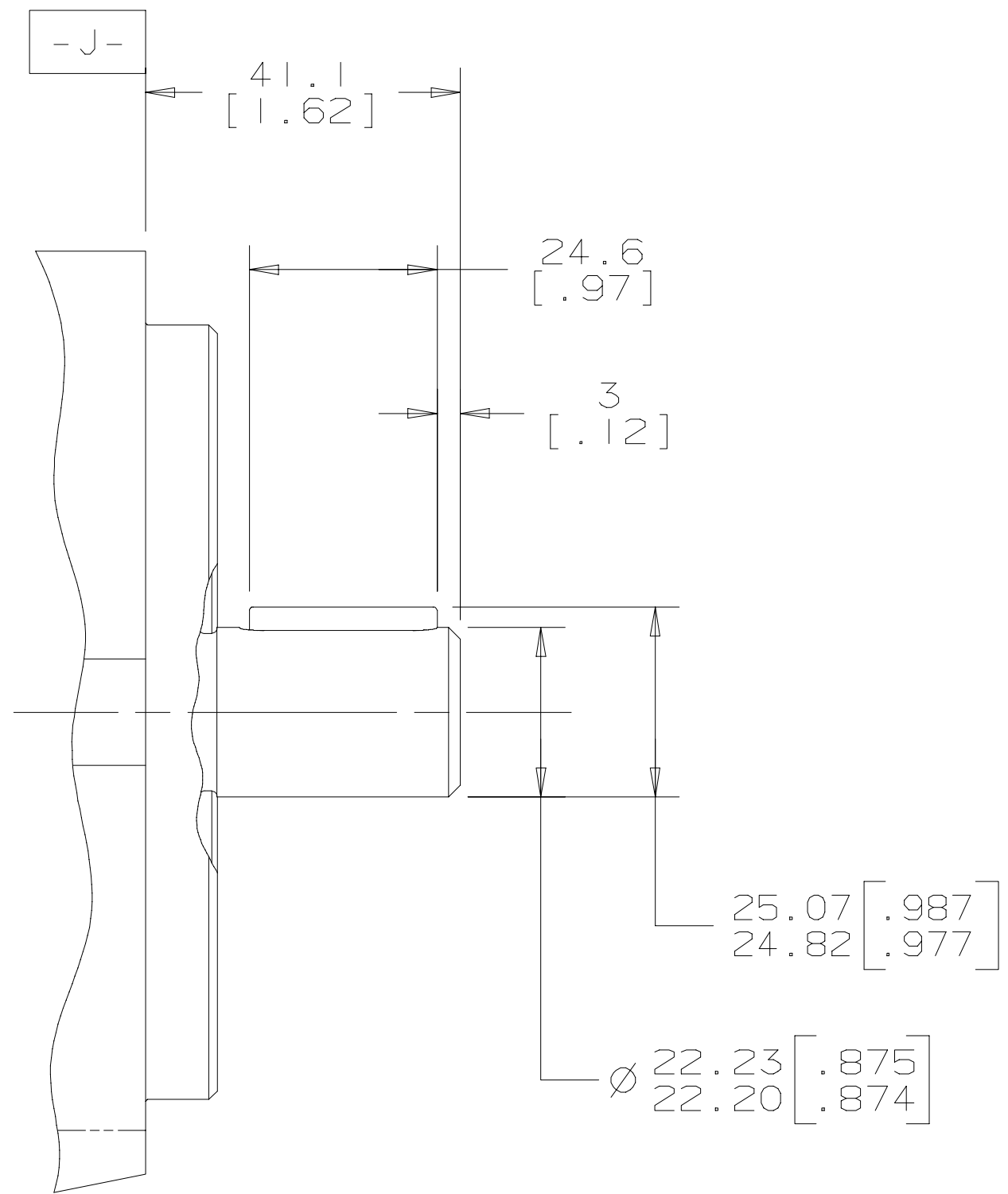

G H

UNLESS OTHERWISE SPECIFIED ALL DIMENSIONS ARE IN INCHES <input type="checkbox"/> MILLIMETERS [INCHES] <input checked="" type="checkbox"/>	DRAWING BASED ON ANSI Y14.5M-1982	
	THE REPRODUCTION, DISTRIBUTION, AND UTILIZATION OF THIS DOCUMENT, AS WELL AS THE COMMUNICATION OF ITS CONTENTS TO OTHERS WITHOUT EXPLICIT AUTHORIZATION IS PROHIBITED. OFFENDERS WILL BE HELD LIABLE FOR THE PAYMENT OF DAMAGES. ALL RIGHTS RESERVED IN THE EVENT OF THE GRANT OF A PATENT, UTILITY MODEL, OR DESIGN. (PER ISO 16016)	
TOLERANCES .X ± - .XX ± REF .XXX ± REF ANGLES ± -	DRAWN BY/DATE DLM 3/7/91 CHECKED BY/DATE CMJ 7/23/91	MATERIAL/HEAT TREAT
UNSPECIFIED RADII ARE - UNSPECIFIED DRAFT ANGLES ARE -	ENGRG BY/DATE DMW 9/10/91 METALLURGY BY/DATE - - -	TITLE SHAFT INSTALLATION
DRAWING FORMAT CADD <input checked="" type="checkbox"/> MANUAL <input type="checkbox"/>	THIRD ANGLE PROJECTION DO NOT SCALE	NUMBER A-290-006
	SCALE 1/1	SHEET 1 OF 1